

REVISION	DESCRIPTION	CHECK	APP	DATE	REV. NOTICE. NO
△1					
△2					
△3					

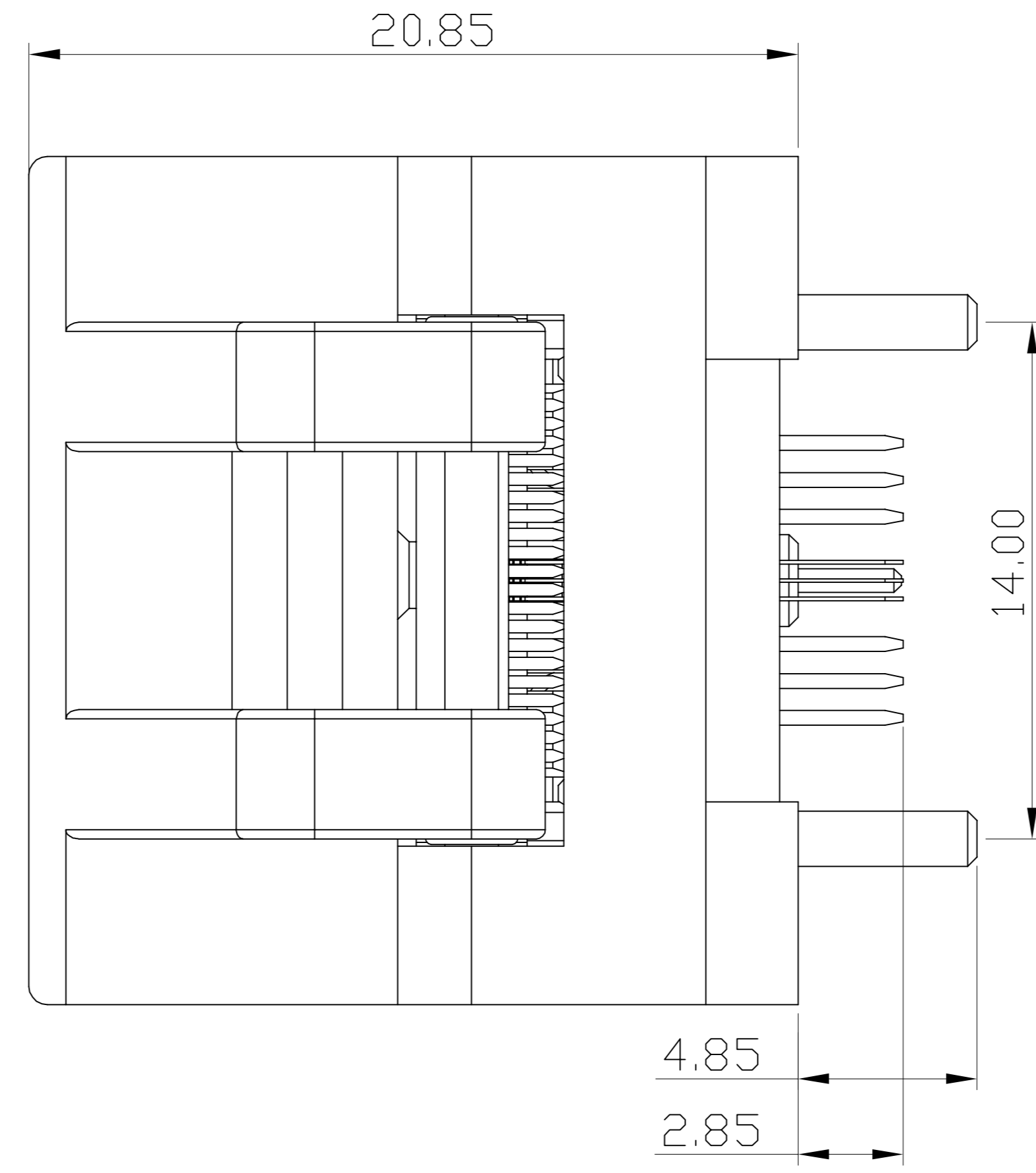

PCB Pattern(TOP View)

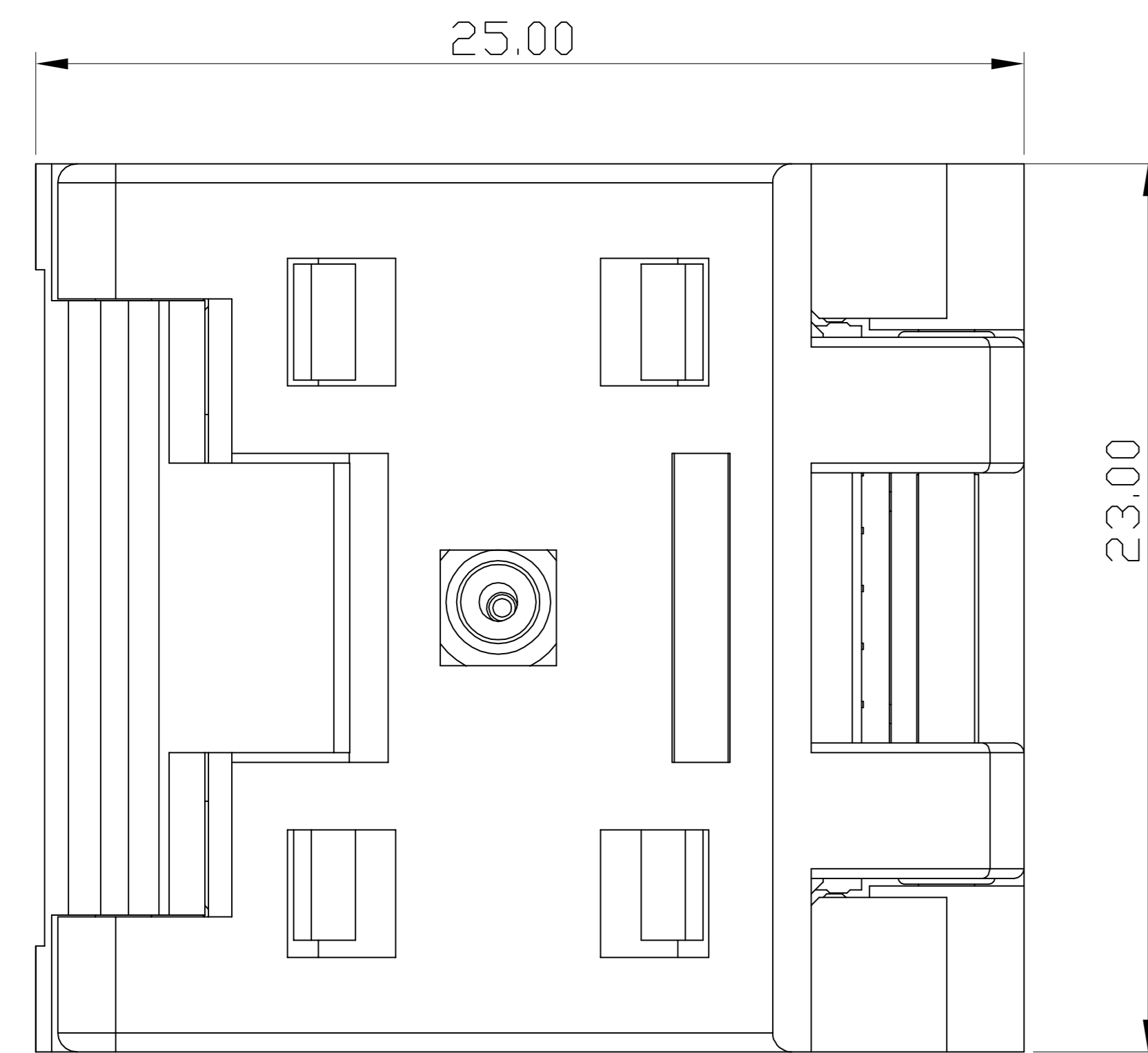
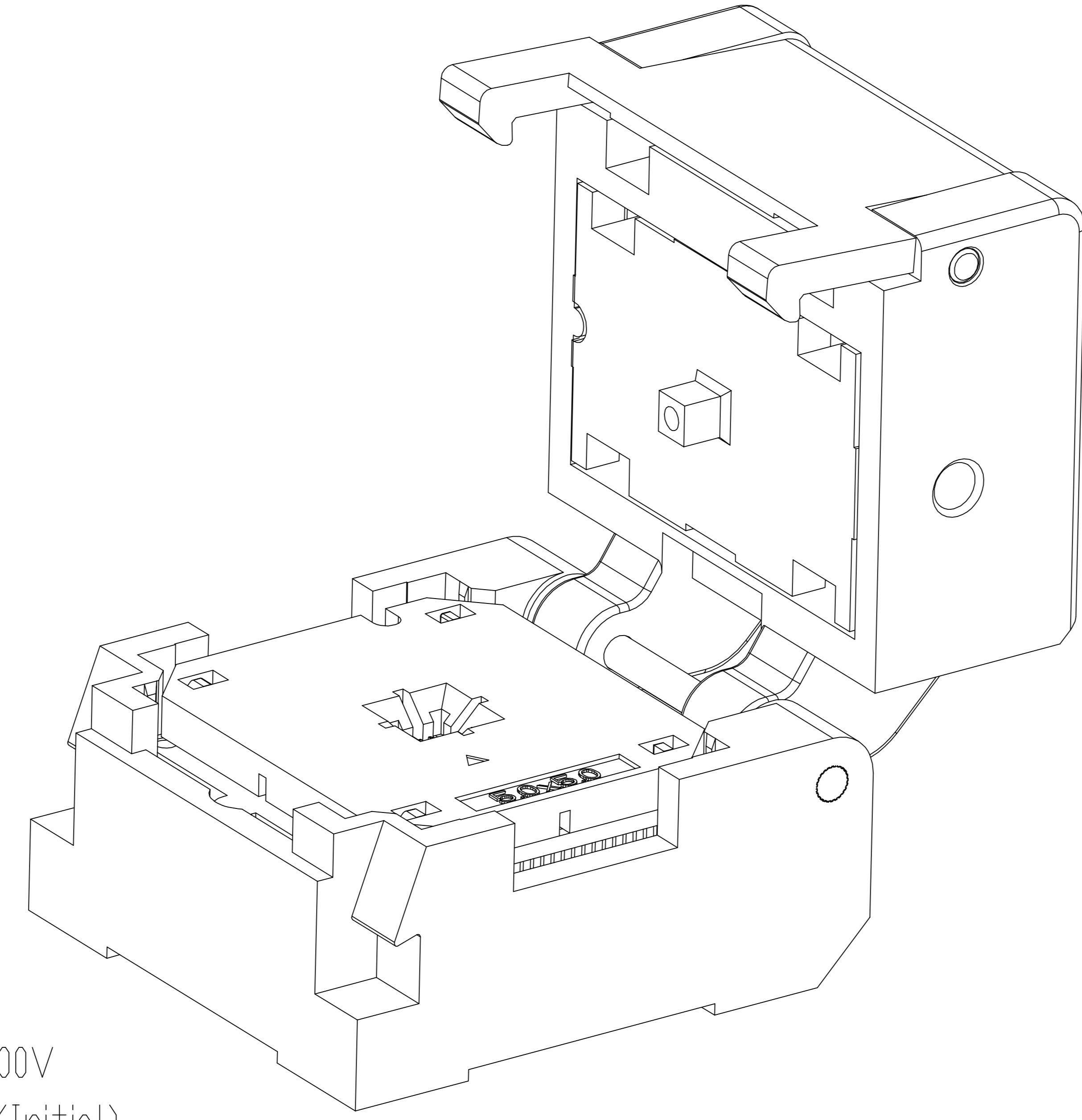
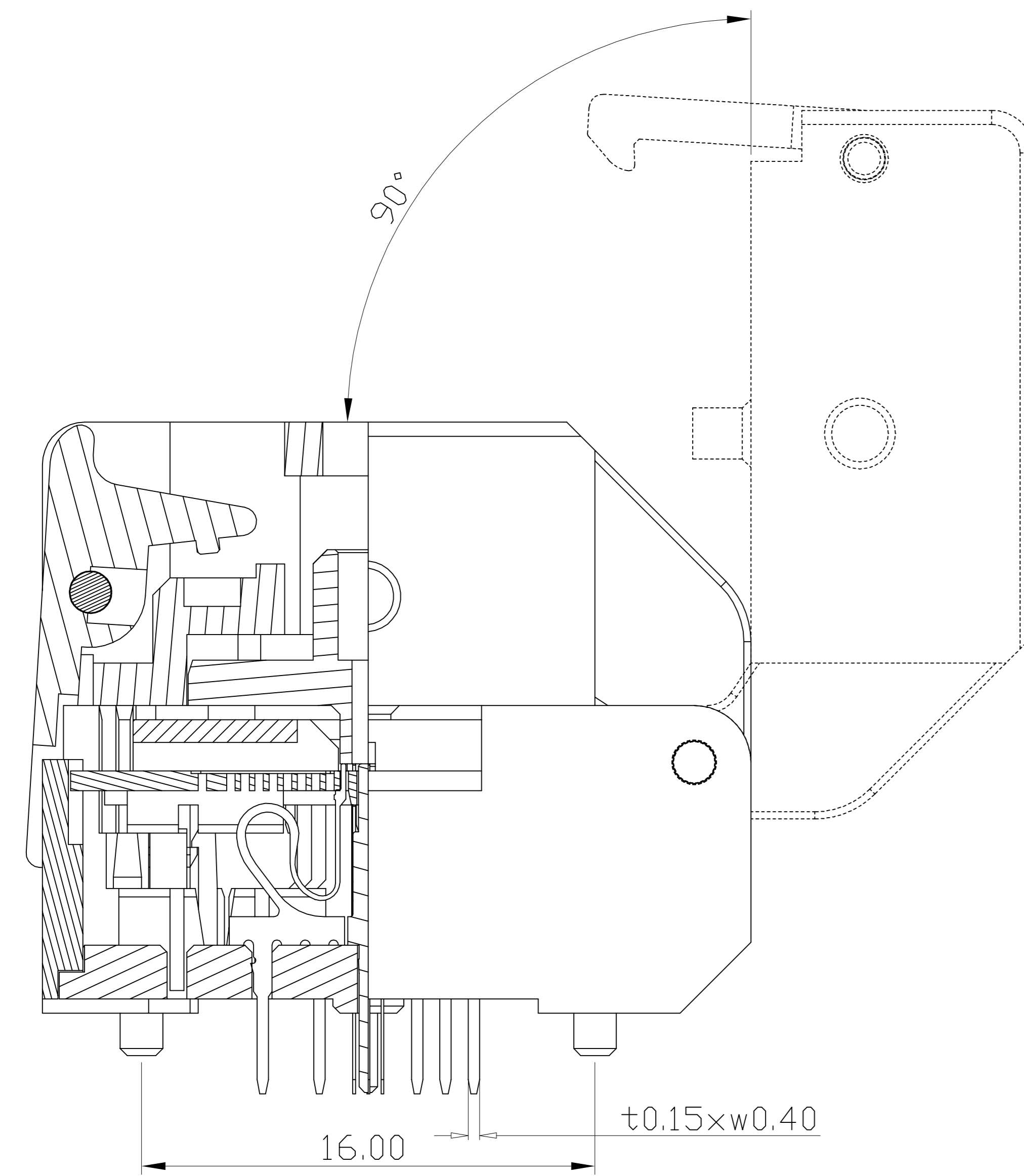
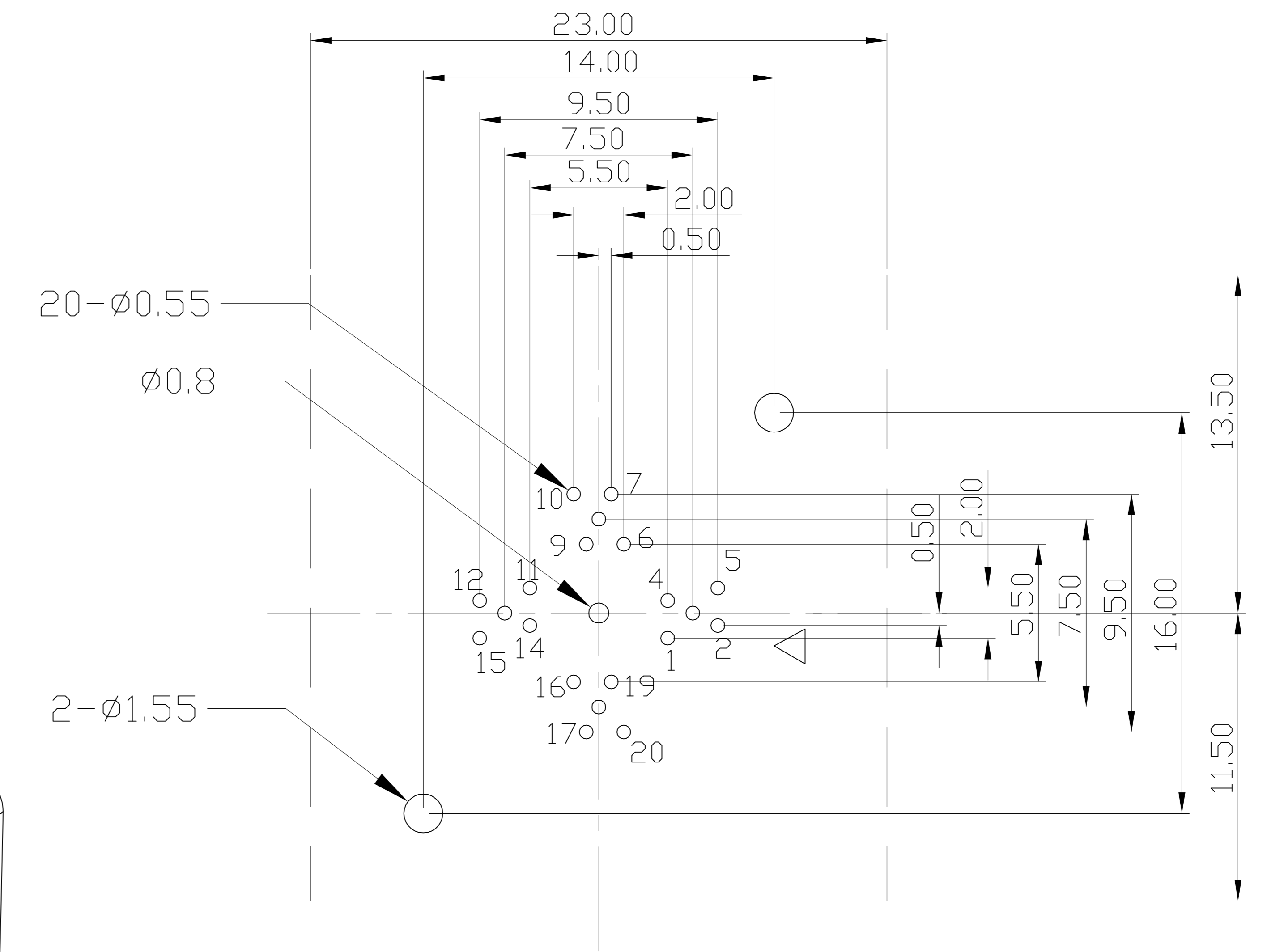

Applicable IC

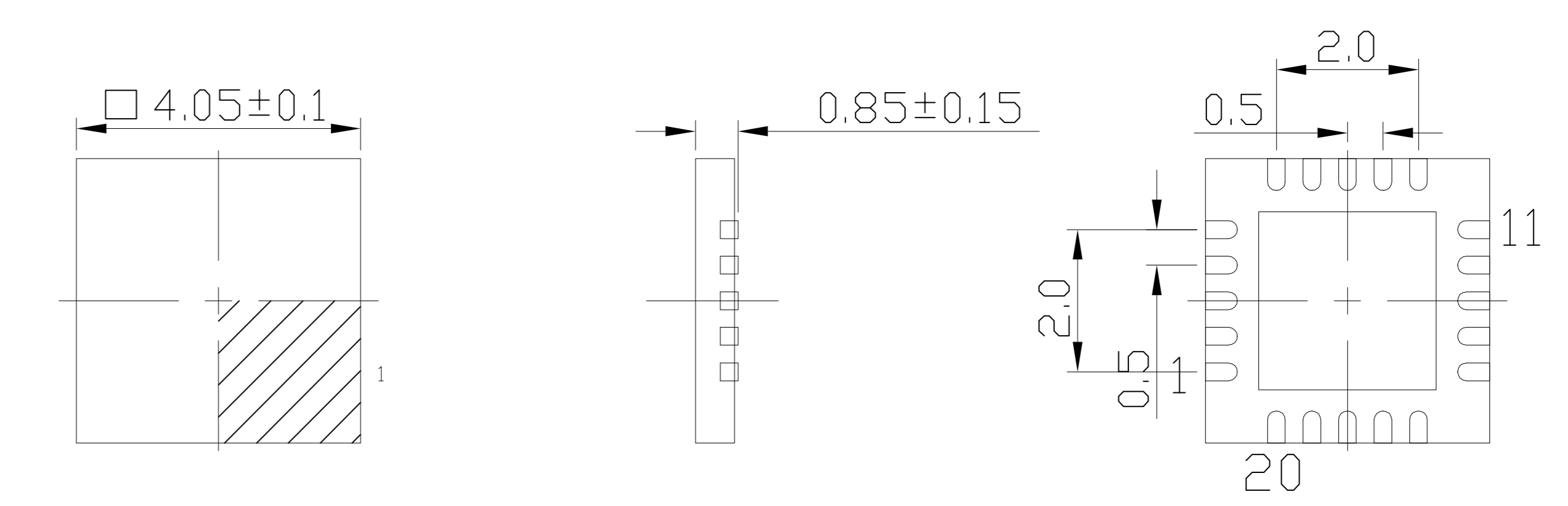

TOP VIEW

SIDE VIEW

BOTTOM VIEW

PERFORMANCE

1. Insulation Resistance: 1000MΩ Min.At DC 500V
2. Dielectric Withstanding Voltage For 1 Minute At AC 700V
3. Contact Resistance 30mΩ MAX. at 10mA and 20mV MAX.(Initial)
4. Current Rating: 1A max.
5. Operation Temperature -40°C ~+155°C
6. Life Span 15,000 Times (Mechanical)
7. Operation Force 2.0 Kg MAX

TOLERANCE	PROJECTION	GENERAL TOLERANCES	±0.10	TITLE	QFN20-0.5 SOCKET
X.	± 0.50	DIMENSION: mm	SCALE: 1:1	CLASS	QFN20-0.5-CP02GT
X.X	± 0.25	APP:	DATE:	DRW. NO	6U-PWQFN-0.5-20-4X4-01
X.XX	± 0.10	CHECK:	DATE:		
X.XXX	± 0.05	DEGK: ENG03	DATE: 20150606		